

Profile Quotation Form

Please fill in corresponding information

HK116

Piston Seal

Hardware Dimensions

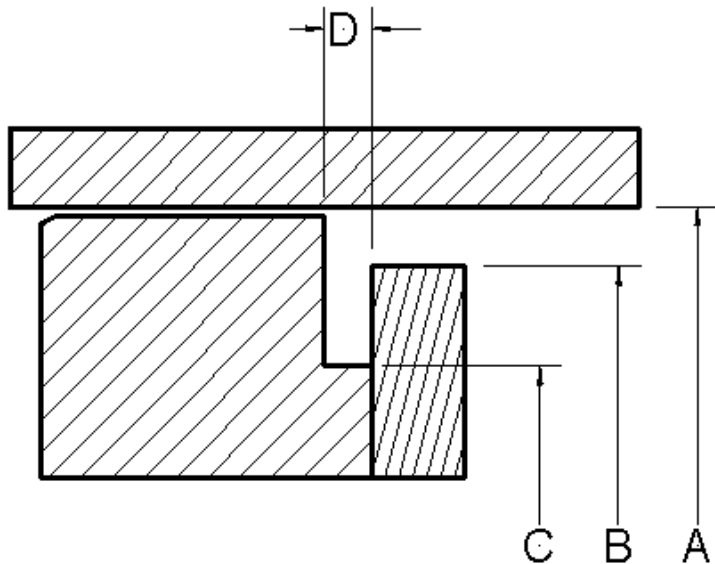

Seal Dimensions

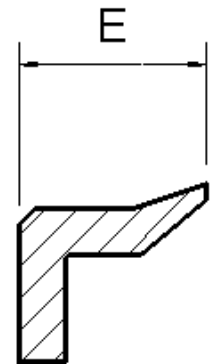

<p>A: _____</p> <p>B: _____</p> <p>C: _____</p> <p>D: _____</p> <p>E: _____</p>	<p>Material: _____</p> <p>Additional Notes:</p>
---	--