

Technical details

Metric

Inch

Operating conditions

Temperature Range -45°C + 120°C
Hardness 55 Shore D

-65°F + 275°F

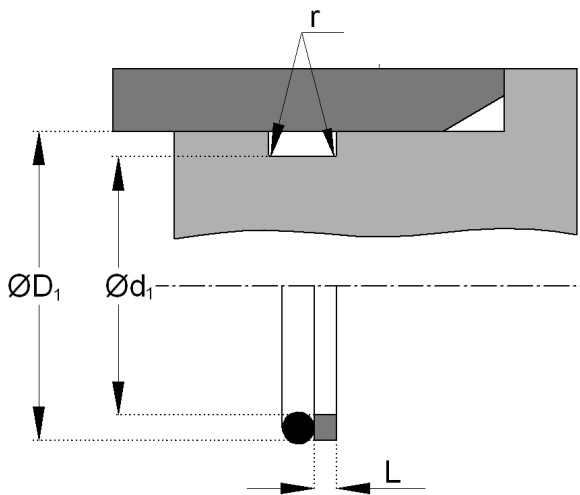

DESIGN

Hallite backups are manufactured from high quality thermoplastic polyester elastomer (TPE). This tough material is long wearing with very good abrasion resistance in both dynamic and static applications and improved extrusion resistance compared to standard urethane or NBR backups. It has high temperature capabilities up to 275°F (135°C) along with a broad range of fluid compatibility including water based fluids.

FEATURES

- Highly extrusion resistant material
- Wide temperature range
- Suitable for use in water based fluids
- Most AS568 sizes available
- Metric sizes available

Hallite also offers back ups in PTFE, polyurethane, and 90 IRHD nitrile rubber. Polyester backup rings are available coloured orange as standard. Other colours are available on request. Please contact your local Hallite sales office for further information.

Backup Rings

Backup Ring

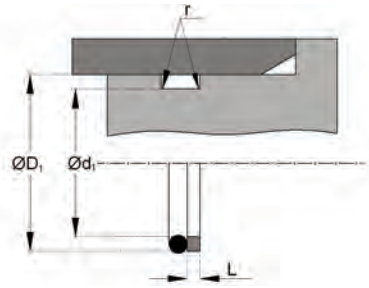

Dash Ref	Ød ₁	S	L	PART No.
-008	0.187	1 / 16	.045	BU008-P
-009	0.218	1 / 16	.045	BU009-P
-010	0.250	1 / 16	.045	BU010-P
-011	0.312	1 / 16	.045	BU011-P
-012	0.375	1 / 16	.045	BU012-P
-013	0.437	1 / 16	.045	BU013-P
-014	0.500	1 / 16	.045	BU014-P
-015	0.562	1 / 16	.045	BU015-P
-016	0.625	1 / 16	.045	BU016-P
-017	0.687	1 / 16	.045	BU017-P
-018	0.750	1 / 16	.045	BU018-P
-019	0.812	1 / 16	.045	BU019-P
-020	0.875	1 / 16	.045	BU020-P
-021	0.937	1 / 16	.045	BU021-P
-022	1.000	1 / 16	.045	BU022-P
-023	1.062	1 / 16	.045	BU023-P
-024	1.125	1 / 16	.045	BU024-P
-025	1.187	1 / 16	.045	BU025-P
-026	1.250	1 / 16	.045	BU026-P
-027	1.312	1 / 16	.045	BU027-P
-028	1.375	1 / 16	.045	BU028-P
-029	1.500	1 / 16	.045	BU029-P
-030	1.625	1 / 16	.045	BU030-P
-031	1.750	1 / 16	.045	BU031-P
-032	1.875	1 / 16	.045	BU032-P
-033	2.000	1 / 16	.045	BU033-P
-034	2.125	1 / 16	.045	BU034-P
-035	1.250	1 / 16	.045	BU035-P

Dash Ref	Ød ₁	S	L	PART No.
-036	2.375	1 / 16	.045	BU036-P
-037	2.500	1 / 16	.045	BU037-P
-038	2.625	1 / 16	.045	BU038-P
-039	2.750	1 / 16	.045	BU039-P
-040	2.785	1 / 16	.045	BU040-P
-041	3.000	1 / 16	.045	BU041-P
-042	3.250	1 / 16	.045	BU042-P
-043	3.500	1 / 16	.045	BU043-P
-044	3.750	1 / 16	.045	BU044-P
-045	4.000	1 / 16	.045	BU045-P
-046	4.250	1 / 16	.045	BU046-P
-047	4.500	1 / 16	.045	BU047-P
-048	4.750	1 / 16	.045	BU048-P
-049	5.000	1 / 16	.045	BU049-P
-050	5.250	1 / 16	.045	BU050-P
-102	0.062	3 / 32	.050	BU102-P
-103	0.093	3 / 32	.050	BU103-P
-104	0.125	3 / 32	.050	BU104-P
-105	0.156	3 / 32	.050	BU105-P
-106	0.187	3 / 32	.050	BU106-P
-107	0.218	3 / 32	.050	BU107-P
-108	0.250	3 / 32	.050	BU108-P
-109	0.312	3 / 32	.050	BU109-P
-110	0.375	3 / 32	.050	BU110-P
-111	0.437	3 / 32	.050	BU111-P
-112	0.500	3 / 32	.050	BU112-P
-113	0.562	3 / 32	.050	BU113-P
-114	0.625	3 / 32	.050	BU114-P

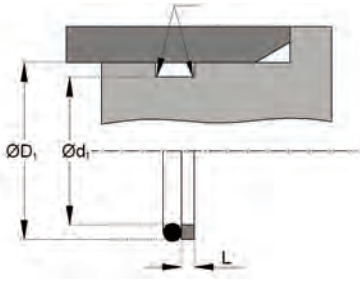

Backup Ring

Dash Ref	Ød ₁	S	L	PART No.
-115	0.687	3 / 32	.050	BU115-P
-116	0.750	3 / 32	.050	BU116-P
-117	0.812	3 / 32	.050	BU117-P
-118	0.875	3 / 32	.050	BU118-P
-119	0.937	3 / 32	.050	BU119-P
-120	1.000	3 / 32	.050	BU120-P
-121	1.062	3 / 32	.050	BU121-P
-122	1.187	3 / 32	.050	BU122-P
-123	1.187	3 / 32	.050	BU123-P
-124	1.250	3 / 32	.050	BU124-P
-125	1.312	3 / 32	.050	BU125-P
-126	1.375	3 / 32	.050	BU126-P
-127	1.437	3 / 32	.050	BU127-P
-128	1.500	3 / 32	.050	BU128-P
-129	1.562	3 / 32	.050	BU129-P
-130	1.625	3 / 32	.050	BU130-P
-131	1.687	3 / 32	.050	BU131-P
-132	1.750	3 / 32	.050	BU132-P
-133	1.812	3 / 32	.050	BU133-P
-134	1.875	3 / 32	.050	BU134-P
-135	1.937	3 / 32	.050	BU135-P
-136	2.000	3 / 32	.050	BU136-P
-137	2.062	3 / 32	.050	BU137-P
-138	0.125	3 / 32	.050	BU138-P
-139	2.187	3 / 32	.050	BU139-P
-140	2.250	3 / 32	.050	BU140-P
-141	2.312	3 / 32	.050	BU141-P
-142	2.375	3 / 32	.050	BU142-P

Dash Ref	Ød ₁	S	L	PART No.
-143	2.437	3 / 32	.050	BU143-P
-144	2.500	3 / 32	.050	BU144-P
-145	2.562	3 / 32	.050	BU145-P
-146	2.625	3 / 32	.050	BU146-P
-147	2.687	3 / 32	.050	BU147-P
-148	2.750	3 / 32	.050	BU148-P
-149	2.812	3 / 32	.050	BU149-P
-150	2.875	3 / 32	.050	BU150-P
-151	3.000	3 / 32	.050	BU151-P
-152	3.250	3 / 32	.050	BU152-P
-153	3.500	3 / 32	.050	BU153-P
-154	3.750	3 / 32	.050	BU154-P
-155	4.000	3 / 32	.050	BU155-P
-156	4.250	3 / 32	.050	BU156-P
-157	4.500	3 / 32	.050	BU157-P
-158	4.750	3 / 32	.050	BU158-P
-159	5.000	3 / 32	.050	BU159-P
-160	5.250	3 / 32	.050	BU160-P
-161	5.500	3 / 32	.050	BU161-P
-162	5.750	3 / 32	.050	BU162-P
-163	6.000	3 / 32	.050	BU163-P
-164	6.250	3 / 32	.050	BU164-P
-165	6.500	3 / 32	.050	BU165-P
-166	6.750	3 / 32	.050	BU166-P
-167	7.000	3 / 32	.050	BU167-P
-168	7.250	3 / 32	.050	BU168-P
-169	7.500	3 / 32	.050	BU169-P
-170	7.750	3 / 32	.050	BU170-P

Backup Ring

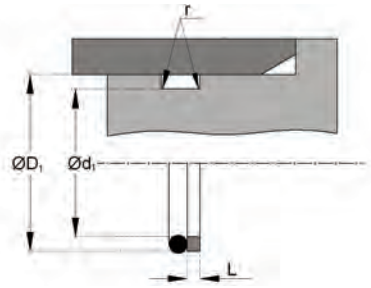

Dash Ref	Ød ₁	S	L	PART No.
-171	8.000	3 / 32	.050	BU171-P
-172	8.250	3 / 32	.050	BU172-P
-173	8.500	3 / 32	.050	BU173-P
-174	8.750	3 / 32	.050	BU174-P
-175	9.000	3 / 32	.050	BU175-P
-176	9.250	3 / 32	.050	BU176-P
-177	9.500	3 / 32	.050	BU177-P
-178	9.750	3 / 32	.050	BU178-P
-201	0.187	1 / 8	.050	BU201-P
-202	0.250	1 / 8	.050	BU202-P
-203	0.312	1 / 8	.050	BU203-P
-204	0.375	1 / 8	.050	BU204-P
-205	0.437	1 / 8	.050	BU205-P
-206	0.500	1 / 8	.050	BU206-P
-207	0.562	1 / 8	.050	BU207-P
-208	0.625	1 / 8	.050	BU208-P
-209	0.687	1 / 8	.050	BU209-P
-210	0.750	1 / 8	.050	BU210-P
-211	0.812	1 / 8	.050	BU211-P
-212	0.875	1 / 8	.050	BU212-P
-213	0.937	1 / 8	.050	BU213-P
-214	1.000	1 / 8	.050	BU214-P
-215	1.062	1 / 8	.050	BU215-P
-216	1.125	1 / 8	.050	BU216-P
-217	1.187	1 / 8	.050	BU217-P
-218	1.250	1 / 8	.050	BU218-P
-219	1.312	1 / 8	.050	BU219-P
-220	1.375	1 / 8	.050	BU220-P

Dash Ref	Ød ₁	S	L	PART No.
-221	1.437	1 / 8	.050	BU221-P
-222	1.500	1 / 8	.050	BU222-P
-223	1.625	1 / 8	.050	BU223-P
-224	1.750	1 / 8	.050	BU224-P
-225	1.875	1 / 8	.050	BU225-P
-226	2.000	1 / 8	.050	BU226-P
-227	2.125	1 / 8	.050	BU227-P
-228	2.250	1 / 8	.050	BU228-P
-229	2.375	1 / 8	.050	BU229-P
-230	2.500	1 / 8	.050	BU230-P
-231	2.625	1 / 8	.050	BU231-P
-232	2.750	1 / 8	.050	BU232-P
-233	2.875	1 / 8	.050	BU233-P
-234	3.000	1 / 8	.050	BU234-P
-235	3.125	1 / 8	.050	BU235-P
-236	3.250	1 / 8	.050	BU236-P
-237	3.375	1 / 8	.050	BU237-P
-238	3.500	1 / 8	.050	BU238-P
-239	3.625	1 / 8	.050	BU239-P
-240	3.750	1 / 8	.050	BU240-P
-241	3.875	1 / 8	.050	BU241-P
-242	4.000	1 / 8	.050	BU242-P
-243	4.125	1 / 8	.050	BU243-P
-244	4.250	1 / 8	.050	BU244-P
-245	4.375	1 / 8	.050	BU245-P
-246	4.500	1 / 8	.050	BU246-P
-247	4.625	1 / 8	.050	BU247-P
-248	4.750	1 / 8	.050	BU248-P

Backup Ring inch

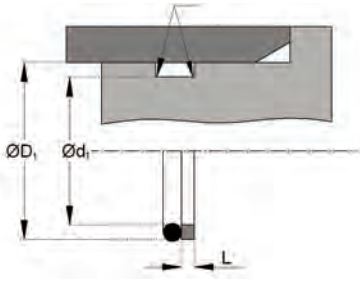

Backup Ring

Dash Ref	Ød ₁	S	L	PART No.
-249	4.875	1 / 8	.050	BU249-P
-250	5.000	1 / 8	.050	BU250-P
-251	5.125	1 / 8	.050	BU251-P
-252	5.250	1 / 8	.050	BU252-P
-253	5.375	1 / 8	.050	BU253-P
-254	5.500	1 / 8	.050	BU254-P
-255	5.625	1 / 8	.050	BU255-P
-256	5.750	1 / 8	.050	BU256-P
-257	5.875	1 / 8	.050	BU257-P
-258	6.000	1 / 8	.050	BU258-P
-259	6.250	1 / 8	.050	BU259-P
-260	6.500	1 / 8	.050	BU260-P
-261	6.750	1 / 8	.050	BU261-P
-262	7.000	1 / 8	.050	BU262-P
-263	7.500	1 / 8	.050	BU263-P
-264	7.500	1 / 8	.050	BU264-P
-265	7.750	1 / 8	.050	BU265-P
-266	8.000	1 / 8	.050	BU266-P
-267	8.250	1 / 8	.050	BU267-P
-268	8.500	1 / 8	.050	BU268-P
-269	8.750	1 / 8	.050	BU269-P
-270	9.000	1 / 8	.050	BU270-P
-271	9.250	1 / 8	.050	BU271-P
-272	9.500	1 / 8	.050	BU272-P
-273	9.750	1 / 8	.050	BU273-P
-274	10.000	1 / 8	.050	BU274-P
-275	10.500	1 / 8	.050	BU275-P
-276	11.000	1 / 8	.050	BU276-P

Dash Ref	Ød ₁	S	L	PART No.
-277	11.500	1 / 8	.050	BU277-F
-278	12.000	1 / 8	.050	BU278-F
-279	13.000	1 / 8	.050	BU279-F
-280	14.000	1 / 8	.050	BU280-F
-281	15.000	1 / 8	.050	BU281-F
-282	16.000	1 / 8	.050	BU282-F
-283	17.000	1 / 8	.050	BU283-F
-284	18.000	1 / 8	.050	BU284-F
-309	0.437	3 / 16	.070	BU309-F
-310	0.500	3 / 16	.070	BU310-F
-311	0.562	3 / 16	.070	BU311-F
-312	0.625	3 / 16	.070	BU312-F
-313	0.687	3 / 16	.070	BU313-F
-314	0.750	3 / 16	.070	BU314-F
-315	0.812	3 / 16	.070	BU315-F
-316	0.875	3 / 16	.070	BU316-F
-317	0.937	3 / 16	.070	BU317-F
-318	1.000	3 / 16	.070	BU318-F
-319	1.062	3 / 16	.070	BU319-F
-320	1.125	3 / 16	.070	BU320-F
-321	1.187	3 / 16	.070	BU321-F
-322	1.250	3 / 16	.070	BU322-F
-323	1.312	3 / 16	.070	BU323-F
-324	1.375	3 / 16	.070	BU324-F
-325	1.500	3 / 16	.070	BU325-F
-326	1.625	3 / 16	.070	BU326-F
-327	1.750	3 / 16	.070	BU327-F
-328	1.875	3 / 16	.070	BU328-F

Backup Ring

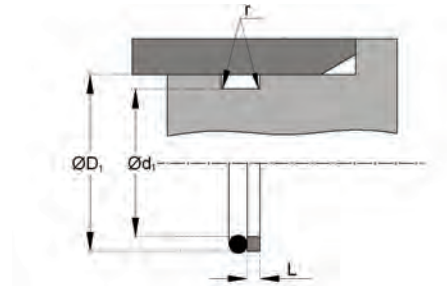

Dash Ref	Ød ₁	S	L	PART No.
-329	2.000	3 / 16	.070	BU329-P
-330	2.125	3 / 16	.070	BU330-P
-331	2.250	3 / 16	.070	BU331-P
-332	2.375	3 / 16	.070	BU332-P
-333	2.500	3 / 16	.070	BU333-P
-334	2.625	3 / 16	.070	BU334-P
-335	2.750	3 / 16	.070	BU335-P
-336	2.875	3 / 16	.070	BU336-P
-337	3.000	3 / 16	.070	BU337-P
-338	3.125	3 / 16	.070	BU338-P
-339	3.250	3 / 16	.070	BU339-P
-340	3.375	3 / 16	.070	BU340-P
-341	3.500	3 / 16	.070	BU341-P
-342	3.625	3 / 16	.070	BU342-P
-343	3.750	3 / 16	.070	BU343-P
-344	3.875	3 / 16	.070	BU344-P
-345	4.000	3 / 16	.070	BU345-P
-346	4.125	3 / 16	.070	BU346-P
-347	4.250	3 / 16	.070	BU347-P
-348	4.375	3 / 16	.070	BU348-P
-349	4.500	3 / 16	.070	BU349-P
-350	4.625	3 / 16	.070	BU350-P
-351	4.750	3 / 16	.070	BU351-P
-352	4.875	3 / 16	.070	BU352-P
-353	5.000	3 / 16	.070	BU353-P
-354	5.125	3 / 16	.070	BU354-P
-355	5.250	3 / 16	.070	BU355-P
-356	5.375	3 / 16	.105	BU356-P

Dash Ref	Ød ₁	S	L	PART No.
-357	5.500	3 / 16	.105	BU357-P
-358	5.625	3 / 16	.105	BU358-P
-359	5.750	3 / 16	.105	BU359-P
-360	5.875	3 / 16	.105	BU360-P
-361	6.000	3 / 16	.105	BU361-P
-362	6.250	3 / 16	.105	BU362-P
-363	6.500	3 / 16	.105	BU363-P
-364	6.750	3 / 16	.105	BU364-P
-365	7.000	3 / 16	.105	BU365-P
-366	7.250	3 / 16	.105	BU366-P
-367	7.500	3 / 16	.105	BU367-P
-368	7.750	3 / 16	.105	BU368-P
-369	8.000	3 / 16	.105	BU369-P
-370	8.250	3 / 16	.105	BU370-P
-371	8.500	3 / 16	.105	BU371-P
-372	8.750	3 / 16	.105	BU372-P
-373	9.000	3 / 16	.105	BU373-P
-374	9.250	3 / 16	.105	BU374-P
-375	9.500	3 / 16	.105	BU375-P
-376	9.750	3 / 16	.105	BU376-P
-377	10.000	3 / 16	.105	BU377-P
-425	4.500	1 / 4	.105	BU425-P
-426	4.625	1 / 4	.105	BU426-P
-427	4.750	1 / 4	.105	BU427-P
-428	4.875	1 / 4	.105	BU428-P
-429	5.000	1 / 4	.105	BU429-P
-430	5.125	1 / 4	.105	BU430-P
-431	5.250	1 / 4	.105	BU431-P

Backup Ring inch

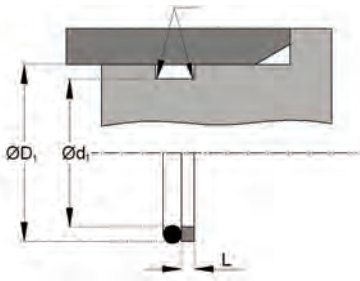

Backup Ring

Dash Ref	Ød ₁	S	L	PART No.
-432	5.375	1 / 4	.105	BU432-P
-433	5.500	1 / 4	.105	BU433-P
-434	6.000	1 / 4	.105	BU434-P
-435	5.750	1 / 4	.105	BU435-P
-436	5.875	1 / 4	.105	BU436-P
-437	6.000	1 / 4	.105	BU437-P
-438	6.250	1 / 4	.105	BU438-P
-439	6.500	1 / 4	.105	BU439-P
-440	6.750	1 / 4	.105	BU440-P
-441	7.000	1 / 4	.105	BU441-P
-442	7.250	1 / 4	.105	BU442-P
-443	7.500	1 / 4	.105	BU443-P
-444	7.750	1 / 4	.105	BU444-P
-445	8.000	1 / 4	.105	BU445-P
-446	8.500	1 / 4	.105	BU446-P
-447	9.000	1 / 4	.105	BU447-P
-448	9.500	1 / 4	.105	BU448-P
-449	10.000	1 / 4	.105	BU449-P
-450	10.500	1 / 4	.105	BU450-P
-451	11.000	1 / 4	.105	BU451-P
-452	11.500	1 / 4	.105	BU452-P
-453	12.000	1 / 4	.105	BU453-P
-454	12.500	1 / 4	.105	BU454-P
-455	13.000	1 / 4	.105	BU455-P
-456	13.500	1 / 4	.105	BU456-P
-460	15.500	1 / 4	.105	BU460-P
-461	16.000	1 / 4	.105	BU461-P
-462	16.500	1 / 4	.105	BU462-P

Dash Ref	Ød ₁	S	L	PART No.
-463	17.000	1 / 4	.105	BU463-P
-464	17.500	1 / 4	.105	BU464-P